



Just think & we will shape it.....

300 X 200 CRATES



Model :CC 32070

O.D. : 300 (L) X 200 (B) X 70 (H) mm.
 11.8" (L) X 7.8" (B) X 2.7"(H) inch.
 I. D. : 265 (L) X 165 (B) X 65 (H) mm.
 10.4" (L) X 6.5" (B) X 2.5"(H) inch.
 Capacity : 3 Ltrs. approx.



Model :CCF 32120

O.D. : 300 (L) X 200 (B) X 120 (H) mm.
 11.8" (L) X 7.8" (B) X 4.7"(H) inch.
 I. D. : 265 (L) X 165 (B) X 115 (H) mm.
 10.4" (L) X 6.5" (B) X 4.5"(H) inch.
 Capacity : 5 ltrs. approx.



Model :CC 32200

O.D. : 300 (L) X 200 (B) X 200 (H) mm.
 11.8" (L) X 7.8" (B) X 7.8"(H) inch.
 I. D. : 265 (L) X 165 (B) X 195 (H) mm.
 10.4" (L) X 6.5" (B) X 7.6"(H) inch.
 Capacity : 8 ltrs. approx.

Available sizes (In CC and CCF version):

32070 : O.D. : 300 (L) X 200 (B) X 70 (H) mm. • I.D. : 265 (L) X 165 (B) X 65 (H) mm. approx.
 11.8" (L) X 7.8" (B) X 2.7"(H) inch. 10.4" (L) X 6.5" (B) X 2.5"(H) inch.

32100 : O.D. : 300 (L) X 200 (B) X 100 (H) mm. • I.D. : 265 (L) X 165 (B) X 95 (H) mm. approx.
 11.8" (L) X 7.8" (B) X 3.9"(H) inch. 10.4" (L) X 6.5" (B) X 3.7"(H) inch.

32120 : O.D. : 300 (L) X 200 (B) X 120 (H) mm. • I.D. : 265 (L) X 165 (B) X 115 (H) mm. approx.
 11.8" (L) X 7.8" (B) X 4.7"(H) inch. 10.4" (L) X 6.5" (B) X 4.5"(H) inch.

32150 : O.D. : 300 (L) X 200 (B) X 150 (H) mm. • I.D. : 265 (L) X 165 (B) X 145 (H) mm. approx.
 11.8" (L) X 7.8" (B) X 5.9"(H) inch. 10.4" (L) X 6.5" (B) X 5.7"(H) inch.

32200 : O.D. : 300 (L) X 200 (B) X 200 (H) mm. • I.D. : 265 (L) X 165 (B) X 195 (H) mm. approx.
 11.8" (L) X 7.8" (B) X 7.8"(H) inch. 10.4" (L) X 6.5" (B) X 7.6"(H) inch.



Model :
Lable Holder
 55 X 35 mm.



Model :LID 32000
 With locking clips (Grey only)



CC 32200 used for storing punch & dies



CC 32200 used in Engineering Industry



CC 32200 used in Textile Industry

400 X 300 CRATES



Model : CC 43090

O.D. : 400 (L) X 300 (B) X 90 (H) mm.
 15.7" (L) X 11.8" (B) X 3.5" (H) inch.
 I.D. : 365 (L) X 265 (B) X 85 (H) mm.
 14.3" (L) X 10.4" (B) X 3.3" (H) inch.
 Capacity : 8 ltrs. approx.



Model : CCF 43175

O.D. : 400 (L) X 300 (B) X 175 (H) mm.
 15.7" (L) X 11.8" (B) X 6.8" (H) inch.
 I.D. : 365 (L) X 265 (B) X 170 (H) mm.
 14.3" (L) X 10.4" (B) X 6.7" (H) inch.
 Capacity : 16 ltrs. approx. (Flat Bottom)



Model : CC 43320

O.D. : 400 (L) X 300 (B) X 320 (H) mm.
 15.7" (L) X 11.8" (B) X 12.6" (H) inch.
 I.D. : 365 (L) X 265 (B) X 315 (H) mm.
 14.3" (L) X 10.4" (B) X 12.4" (H) inch.
 Capacity : 30 ltrs. approx.

Available sizes (In CC and CCF version):

43065 : O.D. : 400 (L) X 300 (B) X 65 (H) mm. • I.D. : 365 (L) X 265 (B) X 60 (H) mm. approx.
 15.7" (L) X 11.8" (B) X 2.5" (H) inch. 14.3" (L) X 10.4" (B) X 2.3" (H) inch.

43090 : O.D. : 400 (L) X 300 (B) X 90 (H) mm. • I.D. : 365 (L) X 265 (B) X 85 (H) mm. approx.
 15.7" (L) X 11.8" (B) X 3.5" (H) inch. 14.3" (L) X 10.4" (B) X 3.3" (H) inch.

43120 : O.D. : 400 (L) X 300 (B) X 120 (H) mm. • I.D. : 365 (L) X 265 (B) X 115 (H) mm. approx.
 15.7" (L) X 11.8" (B) X 4.7" (H) inch. 14.3" (L) X 10.4" (B) X 4.5" (H) inch.

43123 : O.D. : 400 (L) X 300 (B) X 123 (H) mm. • I.D. : 365 (L) X 265 (B) X 118 (H) mm. approx.
 15.7" (L) X 11.8" (B) X 4.8" (H) inch. 14.3" (L) X 10.4" (B) X 4.6" (H) inch.

43150 : O.D. : 400 (L) X 300 (B) X 150 (H) mm. • I.D. : 365 (L) X 265 (B) X 145 (H) mm. approx.
 15.7" (L) X 11.8" (B) X 5.9" (H) inch. 14.3" (L) X 10.4" (B) X 5.7" (H) inch.

43175 : O.D. : 400 (L) X 300 (B) X 175 (H) mm. • I.D. : 365 (L) X 265 (B) X 170 (H) mm. approx.
 15.7" (L) X 11.8" (B) X 6.8" (H) inch. 14.3" (L) X 10.4" (B) X 6.7" (H) inch.

43220 : O.D. : 400 (L) X 300 (B) X 220 (H) mm. • I.D. : 365 (L) X 265 (B) X 215 (H) mm. approx.
 15.7" (L) X 11.8" (B) X 8.6" (H) inch. 14.3" (L) X 10.4" (B) X 8.4" (H) inch.

43240 : O.D. : 400 (L) X 300 (B) X 240 (H) mm. • I.D. : 365 (L) X 265 (B) X 235 (H) mm. approx.
 15.7" (L) X 11.8" (B) X 9.4" (H) inch. 14.3" (L) X 10.4" (B) X 9.2" (H) inch.

43270 : O.D. : 400 (L) X 300 (B) X 270 (H) mm. • I.D. : 365 (L) X 265 (B) X 265 (H) mm. approx.
 15.7" (L) X 11.8" (B) X 10.6" (H) inch. 14.3" (L) X 10.4" (B) X 10.4" (H) inch.

43320 : O.D. : 400 (L) X 300 (B) X 320 (H) mm. • I.D. : 365 (L) X 265 (B) X 315 (H) mm. approx.
 15.7" (L) X 11.8" (B) X 12.6" (H) inch. 14.3" (L) X 10.4" (B) X 12.4" (H) inch.



CC43320 used in engineering industry



CC43150 used in Pouch Industry

43175 : Available in **JR** version (i.e. All four sides and bottom perforated)

4032160 : Available in **JR** version (i.e. All four sides and bottom perforated)



Model :
Lable Holder

4032190 : Available in **CC** version (i.e. Complete Closed) & **CH** version (i.e. Closed with Handle)

4032250 : Available in **JBC** version (i.e. All four sides perforated & bottom closed) & **JR** version (i.e. All four sides & bottom perforated)



Model : JR4032270

4032270 : Available in **CC/CH/JBC & JR** versions (Also called Mini Multipurpose Crates)



CC43270 used in engineering industry

500 x 325 CRATES



Model :CC 53100

O.D. : 500 (L) X 325 (B) X 100 (H) mm.
 19.6" (L) X 12.7" (B) X 3.9"(H) inch.
 I . D. : 465 (L) X 290 (B) X 90 (H) mm.
 18.3" (L) X 11.4" (B) X 3.5"(H) inch.
 Capacity : 13 Ltrs. approx.



Model :CHF 53150

O.D. : 500 (L) X 325 (B) X 150 (H) mm.
 19.6" (L) X 12.7" (B) X 5.9"(H) inch.
 I . D. : 465 (L) X 290 (B) X 140 (H) mm.
 18.3" (L) X 11.4" (B) X 5.5"(H) inch.
 Capacity : 19 Ltrs. approx.



Model :JR 53250

O.D. : 500 (L) X 325 (B) X 250 (H) mm.
 19.6" (L) X 12.7" (B) X 9.8"(H) inch.
 I . D. : 465 (L) X 290 (B) X 240 (H) mm.
 18.3" (L) X 11.4" (B) X 9.4"(H) inch.
 Capacity : 32 Ltrs. approx.



Model :FPO 53150 (with flap)

O.D. : 500 (L) X 325 (B) X 150 (H) mm.
 19.6" (L) X 12.7" (B) X 5.9"(H) inch.
 I . D. : 465 (L) X 290 (B) X 140 (H) mm.
 18.3" (L) X 11.4" (B) X 5.5"(H) inch.
 Capacity : 19 Ltrs. approx.



Model :FPO 53250 (with flap)

O.D. : 500 (L) X 325 (B) X 250 (H) mm.
 19.6" (L) X 12.7" (B) X 9.8"(H) inch.
 I . D. : 465 (L) X 290 (B) X 240 (H) mm.
 18.3" (L) X 11.4" (B) X 9.4"(H) inch.
 Capacity : 32 Ltrs. approx.

Available sizes

(In FPO version):

53100 / 53150 / 53200 / 53250



Model :
 Lable Holder
 (Big)

80 X 55 MM (3.1 X 2.1 inches)

Available sizes (In CC/CCF/CH/CHF/JBC/JR versions):

53100 : O.D. : 500 (L) X 325 (B) X 100 (H) mm. • I.D. : 465 (L) X 290 (B) X 90 (H) mm. approx.
 19.6" (L) X 12.7" (B) X 3.9"(H) inch. 18.3" (L) X 11.4" (B) X 3.5"(H) inch.

53150 : O.D. : 500 (L) X 325 (B) X 150 (H) mm. • I.D. : 465 (L) X 290 (B) X 140 (H) mm. approx.
 19.6" (L) X 12.7" (B) X 5.9"(H) inch. 18.3" (L) X 11.4" (B) X 5.5"(H) inch.

53200 : O.D. : 500 (L) X 325 (B) X 200 (H) mm. • I.D. : 465 (L) X 290 (B) X 190 (H) mm. approx.
 19.6" (L) X 12.7" (B) X 7.8"(H) inch. 18.3" (L) X 11.4" (B) X 7.4"(H) inch.

53250 : O.D. : 500 (L) X 325 (B) X 250 (H) mm. • I.D. : 465 (L) X 290 (B) X 240 (H) mm. approx.
 19.6" (L) X 12.7" (B) X 9.8"(H) inch. 18.3" (L) X 11.4" (B) X 9.4"(H) inch.

53360 : O.D. : 500 (L) X 325 (B) X 360 (H) mm. • I.D. : 465 (L) X 290 (B) X 350 (H) mm. approx.
 19.6" (L) X 12.7" (B) X 14.1"(H) inch. 18.3" (L) X 11.4" (B) X 13.7"(H) inch.



540 X 360 CRATES



Model : JR5436205

O.D. : 540 (L) X 360 (B) X 205 (H) mm.
 21.2" (L) X 14.1" (B) X 8.0" (H) inch.
 I. D. : 510 (L) X 328 (B) X 195 (H) mm.
 20.0" (L) X 12.9" (B) X 7.6" (H) inch.
 Capacity : 32 Ltrs. approx.



Model : JR5436275

O.D. : 540 (L) X 360 (B) X 275 (H) mm.
 21.2" (L) X 14.1" (B) X 10.8" (H) inch.
 I. D. : 510 (L) X 328 (B) X 265 (H) mm.
 20.0" (L) X 12.9" (B) X 10.4" (H) inch.
 Capacity : 44 Ltrs. approx.



Model : CCF5436300

O.D. : 540 (L) X 360 (B) X 300 (H) mm.
 21.2" (L) X 14.1" (B) X 11.8" (H) inch.
 I. D. : 510 (L) X 328 (B) X 290 (H) mm.
 20.0" (L) X 12.9" (B) X 11.4" (H) inch.
 Capacity : 48 Ltrs. approx.



Model : CH5436340

O.D. : 540 (L) X 360 (B) X 340 (H) mm.
 21.2" (L) X 14.1" (B) X 13.3" (H) inch.
 I. D. : 510 (L) X 328 (B) X 330 (H) mm.
 20.0" (L) X 12.9" (B) X 12.9" (H) inch.
 Capacity : 55 Ltrs. approx.



Model : CC5436340

O.D. : 540 (L) X 360 (B) X 340 (H) mm.
 21.2" (L) X 14.1" (B) X 13.3" (H) inch.
 I. D. : 510 (L) X 328 (B) X 330 (H) mm.
 20.0" (L) X 12.9" (B) X 12.9" (H) inch.
 Capacity : 55 Ltrs. approx.



Model : JBC5436400

O.D. : 540 (L) X 360 (B) X 400 (H) mm.
 21.2" (L) X 14.1" (B) X 15.7" (H) inch.
 I. D. : 510 (L) X 328 (B) X 390 (H) mm.
 20.0" (L) X 12.9" (B) X 15.3" (H) inch.
 Capacity : 65 Ltrs. approx.

Available sizes (In CC/CCF/CH/CHF/JBC/JR versions):

5436205: O.D. : 540 (L) X 360 (B) X 205 (H) mm. • I.D. : 510 (L) X 328 (B) X 195 (H) mm. approx.
 21.2" (L) X 14.1" (B) X 8.0" (H) inch. 20.0" (L) X 12.9" (B) X 7.6" (H) inch.

5436300: O.D. : 540 (L) X 360 (B) X 300 (H) mm. • I.D. : 510 (L) X 328 (B) X 290 (H) mm. approx.
 21.2" (L) X 14.1" (B) X 11.8" (H) inch. 20.0" (L) X 12.9" (B) X 11.4" (H) inch.

5436340: O.D. : 540 (L) X 360 (B) X 340 (H) mm. • I.D. : 510 (L) X 328 (B) X 330 (H) mm. approx.
 21.2" (L) X 14.1" (B) X 13.3" (H) inch. 20.0" (L) X 12.9" (B) X 12.9" (H) inch.

5436400: O.D. : 540 (L) X 360 (B) X 400 (H) mm. • I.D. : 510 (L) X 328 (B) X 390 (H) mm. approx.
 21.2" (L) X 14.1" (B) X 15.7" (H) inch. 20.0" (L) X 12.9" (B) X 15.3" (H) inch.

5439345: O.D. : 540 (L) X 390 (B) X 345 (H) mm. • I.D. : 510 (L) X 360 (B) X 335 (H) mm. approx.
 21.2" (L) X 15.3" (B) X 13.5" (H) inch. 20.0" (L) X 14.1" (B) X 13.1" (H) inch.



600 X 400 CRATES



MODEL :JR64120

O.D. : 600 (L) X 400 (B) X 120 (H) mm.
 23.6" (L) X 15.7" (B) X 4.7"(H) inch.
 I . D. : 565 (L) X 365 (B) X 115 (H) mm.
 22.2" (L) X 14.3" (B) X 4.5"(H) inch.
 Capacity : 23 Ltrs. approx.



MODEL :CH64280 (conductive)

O.D. : 600 (L) X 400 (B) X 280 (H) mm.
 23.6" (L) X 15.7" (B) X 11"(H) inch.
 I . D. : 565 (L) X 365 (B) X 275 (H) mm.
 22.2" (L) X 14.3" (B) X 10.8"(H) inch.
 Capacity : 55 Ltrs. approx.



MODEL :CC64320

O.D. : 600 (L) X 400 (B) X 320 (H) mm.
 23.6" (L) X 15.7" (B) X 12.5"(H) inch.
 I . D. : 565 (L) X 365 (B) X 315 (H) mm.
 22.2" (L) X 14.3" (B) X 12.4"(H) inch.
 Capacity : 65 Ltrs. approx.



MODEL :JBC64425

O.D. : 600 (L) X 400 (B) X 425 (H) mm.
 23.6" (L) X 15.7" (B) X 16.7"(H) inch.
 I . D. : 565 (L) X 365 (B) X 420 (H) mm.
 22.2" (L) X 14.3" (B) X 16.5"(H) inch.
 Capacity : 85 Ltrs. approx.



Model : CH64485

O.D. : 600 (L) X 400 (B) X 485 (H) mm.
 23.6" (L) X 15.7" (B) X 19"(H) inch.
 I . D. : 565 (L) X 365 (B) X 480 (H) mm.
 22.2" (L) X 14.3" (B) X 18.8"(H) inch.
 Capacity : 98 Ltrs. approx.



Model :LID64000

(Grey Only And With Locking Clips)

Other available sizes (In CC/CCF/CH/CHF/JBC/JR versions):

64080	: O.D.:600 (L) X 400 (B) X 80 (H) mm.●I.D. : 565 (L) X 365 (B) X 75 (H) mm.	(23.6" (L) X 15.7" (B) X 3.1"(H) inch ● 22.2" (L) X 14.3" (B) X 2.9"(H) inch.)
64120	: O.D.:600 (L) X 400 (B) X120(H) mm.●I.D. : 565 (L) X 365 (B) X115 (H) mm.	(23.6" (L) X 15.7" (B) X 4.7"(H) inch ● 22.2" (L) X 14.3" (B) X 4.5"(H) inch.)
64123	: O.D.:600 (L) X 400 (B) X123 (H) mm.●I.D. : 565 (L) X 365 (B) X118(H) mm.	(23.6" (L) X 15.7" (B) X 4.8"(H) inch ● 22.2" (L) X 14.3" (B) X 4.6"(H) inch.)
64160	: O.D.:600 (L) X 400 (B) X160 (H) mm.●I.D. : 565 (L) X 365 (B) X155 (H) mm.	(23.6" (L) X 15.7" (B) X 6.2"(H) inch ● 22.2" (L) X 14.3" (B) X 6.1"(H) inch.)
64175	: O.D.:600 (L) X 400 (B) X175 (H) mm.●I.D. : 565 (L) X 365 (B) X170(H) mm.	(23.6" (L) X 15.7" (B) X 6.8"(H) inch ● 22.2" (L) X 14.3" (B) X 6.6"(H) inch.)
64200	: O.D.:600 (L) X 400 (B) X200(H) mm.●I.D. : 565 (L) X 365 (B) X195 (H) mm.	(23.6" (L) X 15.7" (B) X 7.8"(H) inch ● 22.2" (L) X 14.3" (B) X 7.6"(H) inch.)
64220	: O.D.:600 (L) X 400 (B) X220(H) mm.●I.D. : 565 (L) X 365 (B) X 215(H) mm.	(23.6" (L) X 15.7" (B) X 8.6"(H) inch ● 22.2" (L) X 14.3" (B) X 8.4"(H) inch.)
64240	: O.D.:600 (L) X 400 (B) X240(H) mm.●I.D. : 565 (L) X 365 (B) X235(H)mm.	(23.6" (L) X 15.7" (B) X 9.4"(H) inch ● 22.2" (L) X 14.3" (B) X 9.2"(H) inch.)
64280	: O.D.:600 (L) X 400 (B) X280 (H) mm.●I.D. : 565 (L) X 365 (B) X275 (H) mm.	(23.6" (L) X 15.7" (B) X 11"(H) inch ● 22.2" (L) X 14.3" (B) X 10.8"(H) inch.)
64285	: O.D.:600 (L) X 400 (B) X285 (H) mm.●I.D. : 565 (L) X 365 (B) X280 (H) mm.	(23.6" (L) X 15.7" (B) X11.2"(H) inch ● 22.2" (L) X 14.3" (B) X11"(H) inch.)
64300	: O.D.:600 (L) X 400 (B) X300 (H) mm.●I.D. : 565 (L) X 365 (B) X295(H) mm.	(23.6" (L) X 15.7" (B) X11.8"(H) inch ● 22.2" (L) X 14.3" (B) X11.6"(H) inch.)
64320	: O.D.:600 (L) X 400 (B) X320(H) mm.●I.D. : 565 (L) X 365 (B) X315(H) mm.	(23.6" (L) X 15.7" (B) X 12.5"(H) inch ● 22.2" (L) X 14.3" (B) X12.4"(H) inch.)
64375	: O.D.:600 (L) X 400 (B)X 375(H) mm.●I.D. : 565 (L) X 365 (B) X370(H) mm.	(23.6" (L) X 15.7" (B) X14.7"(H) inch ● 22.2" (L) X 14.3" (B) X14.5"(H) inch.)
64400	: O.D.:600 (L) X 400 (B) X400 (H) mm.●I.D. : 565 (L) X 365 (B) X395 (H) mm.	(23.6" (L) X 15.7" (B) X15.7"(H) inch ● 22.2" (L) X 14.3" (B) X15.5"(H) inch.)
64425	: O.D.:600 (L) X 400 (B) X425(H) mm.●I.D. : 565 (L) X 365 (B) X420(H) mm.	(23.6" (L) X 15.7" (B) X16.7"(H) inch ● 22.2" (L) X 14.3" (B) X16.5"(H) inch.)
64485	: O.D.:600 (L) X 400 (B) X485(H) mm.●I.D. : 565 (L) X 365 (B) X480(H) mm.	(23.6" (L) X 15.7" (B) X 19"(H) inch ● 22.2" (L) X 14.3" (B) X18.8"(H) inch.)
6142310: O.D. : 610 (L) X 420 (B) X 310 (H) mm. ● I.D. : 575 (L) X 385 (B) X 300 (H) mm. approx. .(24.0" (L) X 16.5" (B) X 12.2" (H) inch ● 22.6" (L) X 15.0" (B) X 11.8" (H) inch.)		

600 x 400 CRATES

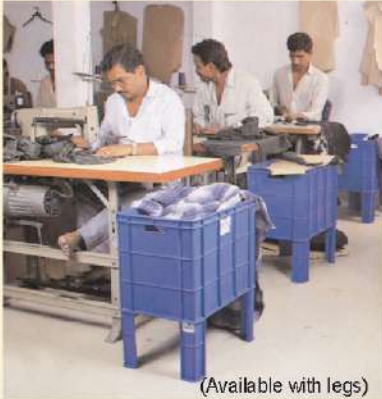

(Available with legs)



Crates used in Garment Industry



Crates used in F & V Industry



Crates used for storing fishes



Crates used in Steel Industry



Crates used in Automobile Industry

MULTIPURPOSE CRATES



Model : CC53300

O.D. : 542 (L) X 360 (B) X 290 (H) mm.
 21.3" (L) X 14.1" (B) X 11.4"(H) inch.
 I. D. : 510 (L) X 327 (B) X 285 (H) mm.
 20.0" (L) X 12.8" (B) X 11.2"(H) inch.
 Capacity : 44 Ltrs. approx.



Model : CH53300

O.D. : 542 (L) X 360 (B) X 290 (H) mm.
 21.3" (L) X 14.1" (B) X 11.4"(H) inch.
 I. D. : 510 (L) X 327 (B) X 285 (H) mm.
 20.0" (L) X 12.8" (B) X 11.2"(H) inch.
 Capacity : 44 Ltrs. approx.



Model : JR53300DW

O.D. : 542 (L) X 360 (B) X 290 (H) mm.
 21.3" (L) X 14.1" (B) X 11.4"(H) inch.
 I. D. : 510 (L) X 327 (B) X 285 (H) mm.
 20.0" (L) X 12.8" (B) X 11.2"(H) inch.
 (DW = Double Wall)



Model : JR53300LW

O.D. : 542 (L) X 360 (B) X 290 (H) mm.
 21.3" (L) X 14.1" (B) X 11.4"(H) inch.
 I. D. : 510 (L) X 327 (B) X 285 (H) mm.
 20.0" (L) X 12.8" (B) X 11.2"(H) inch.
 (LW = Low Weight)



Model : JR53300BJ

O.D. : 542 (L) X 360 (B) X 290 (H) mm.
 21.3" (L) X 14.1" (B) X 11.4"(H) inch.
 I. D. : 510 (L) X 327 (B) X 285 (H) mm.
 20.0" (L) X 12.8" (B) X 11.2"(H) inch.
 (BJ = Big Jali)



Model : JR53300(W/C)

O.D. : 542 (L) X 360 (B) X 290 (H) mm.
 21.3" (L) X 14.1" (B) X 11.4"(H) inch.
 I. D. : 510 (L) X 327 (B) X 285 (H) mm.
 20.0" (L) X 12.8" (B) X 11.2"(H) inch.
 (WC = Without Cut)

Models also available in **HW (Heavy Weight)**, **EEB (Extra Elevated Bottom)** versions



Ice cream Industry



Fruits and Vegetables Industry

GIANT CRATES



Model :CC85425

O.D. : 810 (L) X 568 (B) X 425 (H) mm.
 31.8" (L) X 22.3" (B) X 16.7"(H) inch.
 I . D. : 763 (L) X 521 (B) X 410 (H) mm.
 30.0" (L) X 20.5" (B) X 16.1"(H) inch.
 Capacity : 165 Ltrs. approx.



Model :CH85425

O.D. : 810 (L) X 568 (B) X 425 (H) mm.
 31.8" (L) X 22.3" (B) X 16.7"(H) inch.
 I . D. : 763 (L) X 521 (B) X 410 (H) mm.
 30.0" (L) X 20.5" (B) X 16.1"(H) inch.
 Capacity : 165 Ltrs. approx.



Model :JBC85425

O.D. : 810 (L) X 568 (B) X 425 (H) mm.
 31.8" (L) X 22.3" (B) X 16.7"(H) inch.
 I . D. : 763 (L) X 521 (B) X 410 (H) mm.
 30.0" (L) X 20.5" (B) X 16.1"(H) inch.
 Capacity : 165 Ltrs. approx.



Model :JR85425

O.D. : 810 (L) X 568 (B) X 425 (H) mm.
 31.8" (L) X 22.3" (B) X 16.7"(H) inch.
 I . D. : 763 (L) X 521 (B) X 410 (H) mm.
 30.0" (L) X 20.5" (B) X 16.1"(H) inch.
 Capacity : 165 Ltrs. approx.



Model :JR85425

Used in Floriculture Industry

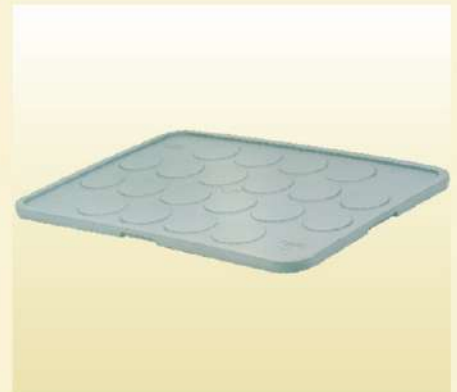

Model :LID 8545000 with Giant Crate

Grey Only & with locking clips only
 available for all Giant crates



Model :JR85425

(Typ. Use in Bakeries)



Model : CH85425

(Typ. Use in Steel Industry)



Model : JR85425 (with wheels)

(Typ. Use in Garment Industry)

JUMBO CRATES



Mini Jumbo Crates :



MODEL : **CC6545195**

O.D. : 650 (L) X 450 (B) X 195 (H) mm.
25.5" (L) X 17.7" (B) X 7.6" (H) inch.

I. D. : 610 (L) X 405 (B) X 185 (H) mm.
24.0" (L) X 15.9" (B) X 7.2" (H) inch.

Capacity : 40 Ltrs. approx.



MODEL : **CH6545195**

O.D. : 650 (L) X 450 (B) X 195 (H) mm.
25.5" (L) X 17.7" (B) X 7.6" (H) inch.

I. D. : 610 (L) X 405 (B) X 185 (H) mm.
24.0" (L) X 15.9" (B) X 7.2" (H) inch.

Capacity : 40 Ltrs. approx.



MODEL : **JBC/JR6545195**

O.D. : 650 (L) X 450 (B) X 195 (H) mm.
25.5" (L) X 17.7" (B) X 7.6" (H) inch.

I. D. : 610 (L) X 405 (B) X 185 (H) mm.
24.0" (L) X 15.9" (B) X 7.2" (H) inch.

Capacity : 40 Ltrs. approx.

6545205 Crates :



MODEL : **CC6545205**

O.D. : 650 (L) X 450 (B) X 205 (H) mm.
25.5" (L) X 17.7" (B) X 8.0" (H) inch.

I. D. : 610 (L) X 405 (B) X 195 (H) mm.
24.0" (L) X 15.9" (B) X 7.6" (H) inch.

Capacity : 48 Ltrs. approx.



MODEL : **CH6545205**

O.D. : 650 (L) X 450 (B) X 205 (H) mm.
25.5" (L) X 17.7" (B) X 8.0" (H) inch.

I. D. : 610 (L) X 405 (B) X 195 (H) mm.
24.0" (L) X 15.9" (B) X 7.6" (H) inch.

Capacity : 48 Ltrs. approx.



MODEL : **JBC/JR6545205**

O.D. : 650 (L) X 450 (B) X 205 (H) mm.
25.5" (L) X 17.7" (B) X 8.0" (H) inch.

I. D. : 610 (L) X 405 (B) X 195 (H) mm.
24.0" (L) X 15.9" (B) X 7.6" (H) inch.

Capacity : 48 Ltrs. approx.

6545315 Crates :



MODEL : **CC/CH6545315**

O.D. : 650 (L) X 450 (B) X 315 (H) mm.
25.5" (L) X 17.7" (B) X 12.4" (H) inch.

I. D. : 610 (L) X 405 (B) X 305 (H) mm.
24.0" (L) X 15.9" (B) X 12.0" (H) inch.

Capacity : 75 Ltrs. approx.

HIGH STORAGE CAPACITY FOR FLORICULTURE, BAKERIES, GARMENTS & FISHERIES



JUMBO CRATES



MODEL : JBC/JR6545315

O.D. : 650 (L) X 450 (B) X 315 (H) mm.
25.5" (L) X 17.7" (B) X 12.4"(H) inch.
I . D. : 610 (L) X 405 (B) X 305 (H) mm.
24.0" (L) X 15.9" (B) X 12.0"(H) inch.
Capacity : 75 Ltrs. approx.



MODEL : JBC / JR6545315DW

O.D. : 650 (L) X 450 (B) X 315 (H) mm.
25.5" (L) X 17.7" (B) X 12.4"(H) inch.
I . D. : 610 (L) X 405 (B) X 305 (H) mm.
24.0" (L) X 15.9" (B) X 12.0"(H) inch.
Capacity : 75 Ltrs. approx. **(Double Wall)**



MODEL : CC / CH6545315DW

O.D. : 650 (L) X 450 (B) X 315 (H) mm.
25.5" (L) X 17.7" (B) X 12.4"(H) inch.
I . D. : 610 (L) X 405 (B) X 305 (H) mm.
24.0" (L) X 15.9" (B) X 12.0"(H) inch.
Capacity : 75 Ltrs. approx. **(Double Wall)**

Maha Jumbo Crates :



MODEL : CC6545480

O.D. : 650 (L) X 450 (B) X 480 (H) mm.
25.5" (L) X 17.7" (B) X 18.8"(H) inch.
I . D. : 610 (L) X 405 (B) X 470 (H) mm.
24.0" (L) X 15.9" (B) X 18.5"(H) inch.
Capacity : 115 Ltrs. approx.



MODEL : CH6545480

O.D. : 650 (L) X 450 (B) X 480 (H) mm.
25.5" (L) X 17.7" (B) X 18.8"(H) inch.
I . D. : 610 (L) X 405 (B) X 470 (H) mm.
24.0" (L) X 15.9" (B) X 18.5"(H) inch.
Capacity : 115 Ltrs. approx.



MODEL : JBC / JR6545480

O.D. : 650 (L) X 450 (B) X 480 (H) mm.
25.5" (L) X 17.7" (B) X 18.8"(H) inch.
I . D. : 610 (L) X 405 (B) X 470 (H) mm.
24.0" (L) X 15.9" (B) X 18.5"(H) inch.
Capacity : 115 Ltrs. approx.

HIGH STORAGE CAPACITY ALSO FOR ICE CREAMS, PENCILS & GARMENT INDUSTRIES



OTHER TYPICAL USE CRATES



ROUND CRATES



Model: RCH18 (Round Crate perforated with Handle Slot)
 Top Dia : 470 mm. approx.(18.5")
 Outside Height : 235 mm. approx.(9.25")



With fishes



With Apples & Rope



Model: RCH22 (Round Crate perforated with Handle Slot)
 Top Dia : 570 mm. approx.(22.5")
 Outside Height : 235 mm. approx.(9.25")

Also available in RCH RCCR &RCHR versions

MEDIUM CRATES



Model CC/CH53305
 O.D. : 525 (L) X 360 (B) X 305 (H) mm.
 20.6" (L) X 14.1" (B) X 12.0"(H) inch.
 I. D. : 490 (L) X 330 (B) X 300 (H) mm.
 19.2" (L) X 12.9" (B) X 11.8"(H) inch.
 Capacity : 48 Ltrs. approx.



Model JBC53305
 O.D. : 525 (L) X 360 (B) X 305 (H) mm.
 20.6" (L) X 14.1" (B) X 12.0"(H) inch.
 I. D. : 490 (L) X 330 (B) X 300 (H) mm.
 19.2" (L) X 12.9" (B) X 11.8"(H) inch.
 Capacity : 48 Ltrs. approx.



SQUARE CRATES



Model JBC/JR 4645183
 O.D. : 460 (L) X 450 (B) X 183 (H) mm.
 18.1" (L) X 17.7" (B) X 7.2"(H) inch.
 I. D. : 410 (L) X 407 (B) X 173 (H) mm.
 16.1" (L) X 16.0" (B) X 6.8"(H) inch.
 Capacity : 28 Ltrs. approx.



**Typical Use of
 JBC 4645183 With Jelly**



OTHER TYPICAL USE CRATES



SOFT BREAD CRATES

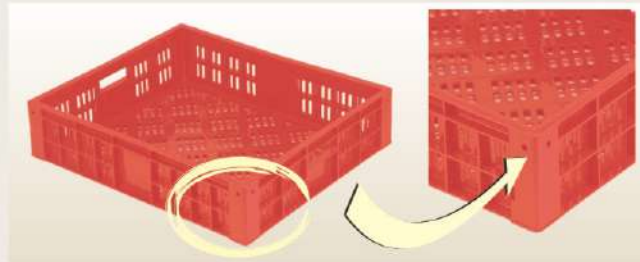

Special Double Wall provided at four corners to strengthen the crates



Stacking

Model JR 5748140

O.D. : 570 (L) X 485 (B) X 140 (H) mm.
 22.4" (L) X 19.0" (B) X 5.5"(H) inch.
 I. D. : 540 (L) X 456 (B) X 131 (H) mm.
 21.2" (L) X 17.9" (B) X 5.1"(H) inch.
 Capacity : 32 Ltrs. approx.

DAIRY INDUSTRY CRATES :



MODEL : CH 4737175 P

O.D. : 471 (L) X 378 (B) X 175 (H) mm.
 18.5" (L) X 14.8" (B) X 6.8"(H) inch.
 I. D. : 427 (L) X 335 (B) X 162 (H) mm.
 16.8" (L) X 13.1" (B) X 6.3"(H) inch.
 Capacity : 23 Ltrs. approx.



MODEL : CH 4737160 P

O.D. : 471 (L) X 378 (B) X 160 (H) mm.
 18.5" (L) X 14.8" (B) X 6.2"(H) inch.
 I. D. : 427 (L) X 335 (B) X 144 (H) mm.
 16.8" (L) X 13.1" (B) X 5.6"(H) inch.
 Capacity : 20 Ltrs. approx.



MODEL : NDDB DESIGN (Pouch Crate)

O.D. : 570 (L) X 298 (B) X 173 (H) mm.
 22.4" (L) X 11.7" (B) X 6.8"(H) inch.
 I. D. : 527 (L) X 230 (B) X 164 (H) mm.
 20.7" (L) X 9.0" (B) X 6.4"(H) inch.
 (Also available with new mould)

BOTTLE INDUSTRY CRATES :



MODEL : BC-48DW (Double Wall)

FULL DEPTH 48 BOTTLE CRATE
POCKET SIZE : 82 X 39 MM.
POCKET HEIGHT : 90 MM.
CAPACITY : 180 ML. BOTTLE
O.D. : 532 X 446 X 174 MM.
 20.9" X 17.5" X 6.8"
I.D. : 500 X 414 X 16.5 MM.
 19.6" X 16.2" X 0.6"



MODEL : BC- 2400LW (Low Weight)

HALF DEPTH 24 BOTTLE CRATE
POCKET SIZE : 61 X 61 MM.
CAPACITY : 200 TO 300 ML. BOTTLE
O.D : 420 X 280 X 140 MM.
 16.5" X 11.0" X 5.5"
I.D : 400 X 260 X 130 MM.
 15.7" X 10.2" X 5.1"



MODEL : BCFDHD - 24

FULL DEPTH HALF DISPLAY- 24 BOTTLE CRATE
POCKET SIZE : 63 X 63 MM
CAPACITY: 250 TO 350 ML BOTTLE
O.D : 436 X 305 X 275 MM
 17.1" X 12.0" X 10.8"
I.D : 409 X 276 X 265 MM
 16.1" X 10.8" X 10.4"

VARIOUS INDUSTRIES



Model No.: **CC 32150**
(Tray along with Dies kept in Crate with Lid)



Crates used with fabrication as per customer's requirement



Model No.: **CH53200**
(used in Postal Industry)



Model No.: **JR 64120** (used in Cake Industry)



Model No.: **CH 53250**
(used in Engg. Industry)

PP CORRUGATED CRATES



Universal Box



Assembly Parts Box



PP Crate with Aluminium Profile



Foldable Frame Welded Partitions



Self Locking Stacking Partition



Tray Partition for Sunlight Protector in Cars

ICE BOXES



MODEL : RIC25LTR (With Tap)
 O.D. : 500 (L) X 335 (B) X 303 (H) mm.
 19.6" (L) X 13.1" (B) X 11.9"(H) inch.
 I . D. : 390 (L) X 282 (B) X 252 (H) mm.
 15.3" (L) X 11.1" (B) X 9.9"(H) inch.
 Capacity : 25 Ltrs. Approx.
 (Also available with vending lid & without tap)



MODEL : RIC50LTR (Without Tap)
 O.D. : 645 (L) X 405 (B) X 420 (H) mm.
 25.3" (L) X 15.9" (B) X 16.5"(H) inch.
 I . D. : 520 (L) X 350 (B) X 340 (H) mm.
 20.4" (L) X 13.7" (B) X 13.3"(H) inch.
 Capacity : 50 Ltrs. Approx.
 (Also available with vending lid & with tap)



For storing & transporting
soft drinks



For storing & transporting
blood packets



**MODEL : RIC100LTRVL
(with Vending Lid)**

O.D. : 750 (L) X 530 (B) X 520 (H) mm.
 29.5" (L) X 20.8" (B) X 20.4"(H) inch.
 I . D. : 650 (L) X 430 (B) X 390 (H) mm.
 25.5" (L) X 16.9" (B) X 15.3"(H) inch.
 Capacity : 100 Ltrs. Approx.
 (Also available without vending lid & without tap)



**MODEL : RIC150LTR
(with Drain Cap)**

O.D. : 840(L) X 575 (B) X 745 (H) mm.
 33" (L) X 22.6" (B) X 29.3"(H) inch.
 I . D. : 680 (L) X 450 (B) X 600 (H) mm.
 26.7" (L) X 17.7" (B) X 23.6"(H) inch.
 Capacity : 150 Ltrs. Approx.
 (Also available with vending lid & without tap)



**MODEL : RICBOX220L
(with Drain Cap)**

O.D. : 1050 (L) X 640 (B) X 750 (H) mm.
 41.3" (L) X 25.1" (B) X 29.5"(H) inch.
 I . D. : 890 (L) X 520 (B) X 600 (H) mm.
 35" (L) X 20.4" (B) X 23.6"(H) inch.
 Capacity : 220 Ltrs. Approx.
 (Also without tap & lid separately available.)

ECONOMY ICE BOXES



MODEL : RIC20LTRWT(Without tap)
 O.D. : 410 (L) X 290 (B) X 320 (H) mm.
 16.1" (L) X 11.4" (B) X 12.5"(H) inch.
 I . D. : 320 (L) X 250 (B) X 255 (H) mm.
 12.5" (L) X 9.8" (B) X 10.0"(H) inch.
 Capacity : 20 Ltrs. approx.
 (Also available with tap)



MODEL : RIC50LTRWT(Without tap)
 O.D. : 605 (L) X 390 (B) X 330 (H) mm.
 23.8" (L) X 15.3" (B) X 12.9"(H) inch.
 I . D. : 510 (L) X 350 (B) X 285 (H) mm.
 20" (L) X 13.7" (B) X 11.2"(H) inch.
 Capacity : 50 Ltrs. approx.
 (Also available with tap)

BLOW MOULDED ICE BOXES



**MODEL : BIC50LTRVL(50 ltrs. approx.)
(With Tap & with Vending Lid)**
 (Also available without tap & without vending lid)
 O.D. 630 (L) X 375 (B) X 380 (H) MM. approx.
 24.8" (L) X 14.7" (B) X 14.9" (H) .

FISH INDUSTRY CRATES



“ROTO MOULDED INSULATED DOUBLE WALLED ICE BOXES & TUBS (SHIPPERS)”.



Model : RSHIPPERTUB310
 O.D. : 915 (L) X 715 (B) X 765 (H) mm.
 38 (L) X 28 (B) X 30 (H) inches
 Capacity : 310 ltrs. approx.



Model : RSHIPPERTUB460
 O.D. : 1230 (L) X 1030 (B) X 580 (H) mm.
 48 (L) X 41 (B) X 23 (H) inches
 Capacity : 460 ltrs. approx.



Model : RSHIPPERTUB660
 O.D. : 1230 (L) X 1030 (B) X 750 (H) mm.
 48 (L) X 41 (B) X 30 (H) inches
 Capacity : 660 ltrs. approx.



Model : RSHIPPERTUB1000
 O.D. : 1470 (L) X 1180 (B) X 895 (H) mm.
 58 (L) X 46 (B) X 35 (H) inches
 Capacity : 1000 ltrs. approx.



Model : RSHIPPERLID310
 (Lid for 310 ltrs. Ice Tubs)



Model : RSHIPPERLID460/660
 (Lid for 460/660 ltrs. Ice Tubs)



Model : RSHIPPERLID1000
 (Lid for 1000 ltrs. Ice Tubs)

OTHER CRATES



Model : JBC/JR73070
 O.D. : 772 (L) X 335 (B) X 70 (H) mm.
 30.3" (L) X 13.1" (B) X 2.7" (H) inch.
 I . D. : 735 (L) X 300 (B) X 60 (H) mm.
 28.9" (L) X 11.8" (B) X 2.3" (H) inch.
 Capacity : 13 Ltrs. approx.



Model : CC/CH73175
 O.D. : 772 (L) X 335 (B) X 175 (H) mm.
 30.3" (L) X 13.1" (B) X 6.8" (H) inch.
 I . D. : 735 (L) X 300 (B) X 165 (H) mm.
 28.9" (L) X 11.8" (B) X 6.4" (H) inch.
 Capacity : 36 Ltrs. approx.



Model : JBC/JR73175
 O.D. : 772 (L) X 335 (B) X 175 (H) mm.
 30.3" (L) X 13.1" (B) X 6.8" (H) inch.
 I . D. : 735 (L) X 300 (B) X 165 (H) mm.
 28.9" (L) X 11.8" (B) X 6.4" (H) inch.
 Capacity : 36 Ltrs. approx.

FISH INDUSTRY CRATES



JR64080 used in Tunnel Freezing Process



Preserving with Ice for transportation is easy with CC6545315



Convenience for Weightment with CC6545315



Model No. :
CC/JR6545615 crates (used in Fishing)



FPO CRATES & BINS



MODEL: FPO CRATE1 & 1P

O.D. : 95 (L) X 102 (B) X 52 (H) mm.
 3.7" (L) X 4.0" (B) X 2.0"(H) inch.
 I . D. : 61 (L) X 90 (B) X 50 (H) mm.
 2.4" (L) X 3.5" (B) X 1.9"(H) inch.
 Capacity : 400 gms. approx.
 Effective Height : 25 mm. (0.9")



MODEL: FPO CRATE5

O.D. : 160 (L) X 115 (B) X 80 (H) mm.
 6.2" (L) X 4.5" (B) X 3.0"(H) inch.
 I . D. : 120 (L) X 100 (B) X 75 (H) mm.
 4.7" (L) X 3.9" (B) X 2.9"(H) inch.
 Capacity : 1 kgs. approx.
 Effective Height : 45 mm. (1.8")



MODEL: FPO CRATE15

O.D. : 200 (L) X 125 (B) X 100 (H) mm.
 7.8" (L) X 4.9" (B) X 3.9"(H) inch.
 I . D. : 160 (L) X 105 (B) X 190(H) mm.
 6.2" (L) X 4.1" (B) X 7.4"(H) inch.
 Capacity : 10 kgs. approx.
 Effective Height : 50 mm. (1.96")



MODEL: FPO CRATE25

O.D. : 230 (L) X 150 (B) X 125 (H) mm.
 9.0" (L) X 5.9" (B) X 4.9"(H) inch.
 I . D. : 180 (L) X 130 (B) X 115 (H) mm.
 7.0" (L) X 5.1" (B) X 4.5"(H) inch.
 Capacity : 13 kgs. approx.
 Effective Height : 55 mm. (2.16")



MODEL: FPO CRATE35

O.D. : 300 (L) X 210 (B) X 160 (H) mm.
 11.8" (L) X 8.2" (B) X 6.2"(H) inch.
 I . D. : 240 (L) X 190 (B) X 150 (H) mm.
 9.4" (L) X 7.4" (B) X 5.9"(H) inch.
 Capacity : 17 kgs. approx.
 Effective Height : 80 mm. (3.14")



MODEL: FPO CRATE45

O.D. : 350 (L) X 210 (B) X 200 (H) mm.
 13.7" (L) X 8.2" (B) X 7.8"(H) inch.
 I . D. : 305 (L) X 190 (B) X 190 (H) mm.
 12.0" (L) X 7.4" (B) X 7.4"(H) inch.
 Capacity : 20 kgs. approx.
 Effective Height : 105 mm. (4.1")



MODEL: FPO CRATE50

O.D. : 515 (L) X 310 (B) X 200 (H) mm.
 20.2" (L) X 12.2" (B) X 7.8"(H) inch.
 I . D. : 425 (L) X 282 (B) X 187 (H) mm.
 16.7" (L) X 11.1" (B) X 7.3"(H) inch.
 Capacity : 25 kgs. approx.
 Effective Height : 100 mm. (4.0")



MODEL: FPO 53250

O.D. : 500 (L) X 325 (B) X 250 (H) mm.
 19.6" (L) X 12.7" (B) X 9.8"(H) inch.
 I . D. : 465 (L) X 290 (B) X 240 (H) mm.
 18.3" (L) X 11.4" (B) X 9.4"(H) inch.
 Size of Opening : 216 X 128 (H) mm.
 8.5" X 5.0"(H) inches

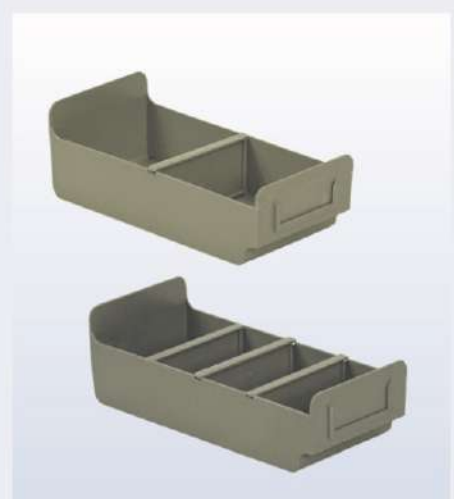

Modular Storage Crates with removable partitions

FPO CRATES & BINS



Model No. : CC8080

O.D. : 80 (L) X 80 (B) X 31(H) mm.
3.1" (L) X 3.1"(B) X 1.2"(H) inches



Model No. : CC16080

O.D. : 160 (L) X 80 (B) X 31(H) mm.
6.2" (L) X 3.1"(B) X 1.2"(H) inches

These crates are provided with convenient slots to make them modular and can be inserted into each other to give various combinations of crates to suit industrial needs.

Model : ECC12

O.D. : 230 (L) X 164 (B) X 154 (H) mm.

O.D. : 9" (L) X 6.4" (B) X 6" (H) inc.

12 drawers (4 rows x 3 columns)

The back side of the Crate is partially opened. Arrangement holes are available on the backside for fixing on the wall.

ELECTRO CONVEYANCE CRATE



TRANSPARENT CRATE DRAWER

O.D. : 149 (L) X 72 (B) X 30.75 (H) mm.

O.D. : 5.8" (L) X 2.8" (B) X 1.21" (H) inc.

MODEL : FS-SS-5

Single sided with 6 channels for FPO 5 Crates

(Double Sided also available)

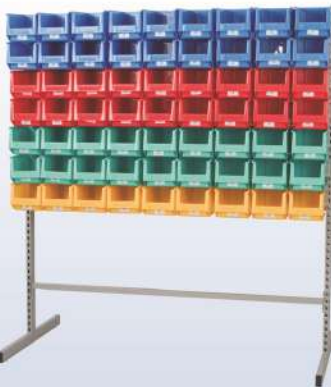

MODEL : FS-SS-25

Single Sided with 7 Channels & 63 nos. of FPO 25 Crates
(Double Sided also available)



MODEL : FS-DS-35

Double sided with 12 Channels & 72 nos. of FPO 35 Crates



MODEL : FS-SS-45

Single sided with 5 Channels & 30 nos. Of FPO 45 Crates
(Double Sided also available)

NO. OF FPO CRATES CRATES (AND MAX CRATES ALSO) WHICH CAN BE MOUNTED ON NEW BOLTLESS FPO STAND

Sr. No.	Crate Model	Quantity on each Channel	Total No. of crates which can be mounted	
			No. of Channel in FS - SS	No. of Channel in FS - DS
1.	FPO - 5	11	09	18
2.	FPO - 15	11	09	18
3.	FPO - 25	09	07	14
4.	FPO - 35	06	06	12
5.	FPO - 45	06	05	10
6.	MAX - 20	10	09	19
7.	MAX - 30	07	09	18
8.	MAX - 40	07	09	18

MAX CRATES & BINS



Model : MAXCRATE10
 O.D. 173 (L) X 96 (B) X 86 (H) mm.
 6.8" (L) X 3.7" (B) X 3.3" (H) inches



Model : MAXCRATE20
 O.D. 230 (L) X 130 (B) X 125 (H) mm.
 9.0" (L) X 5.1" (B) X 4.9" (H) inches



Model : MAXCRATE30
 O.D. : 300 (L) X 180 (B) X 145 (H) mm.
 11.8" (L) X 7.0" (B) X 5.7" (H) inches



Model : MAXCRATE40
 O.D. : 450 (L) X 180 (B) X 145 (H) mm.
 17.7" (L) X 7.0" (B) X 5.7" (H) inches



Model : MAXCRATE47
 O.D. : 365 (L) X 295 (B) X 145(H) mm.
 14.3" (L) X 11.6" (B) X 5.7" (H) inches



Model : MAXCRATE70
 O.D. : 450 (L) X 410 (B) X 215(H) mm.
 16.1" (L) X 17.7" (B) X 8.4" (H) inches

MAX Crates which can be mounted on following Louvre Panels :

	MAX47	MAX70
1. MLP4545 :	3	2
2. MLP4561 :	4	3
3. MLP4591 :	6	4
4. MLP45183 :	9	8

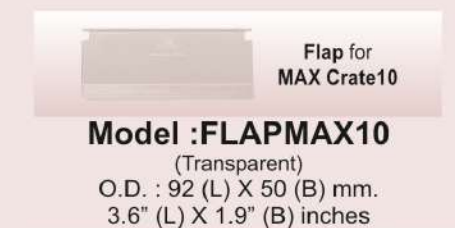
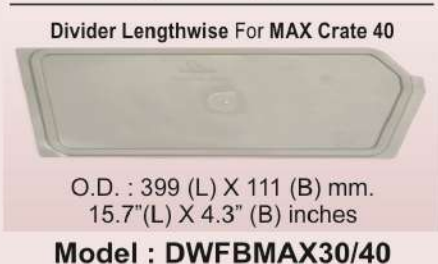

MAX CRATES & BINS



Complete set of **MAX30**

Complete set of **MAX- 40**



Model : **MAX40**
with widthwise dividers



Model : **DWMAX30/40**

(Divider Widthwise suitable for MAX crates 20/30/40)

MAX LOUVRE PANELS (Wall Mountable)

Model : **MLP 4545**

(457(W) X 457(H) mm. / 17.9"(W) X 17.9"(H) inches)



MAX Louvre Panel
Model : **MLP4545**



MAX 20 mounted on
Model : **MLP4545**

Model : **MLP 4561**

(457(W) X 610(H) mm. / 17.9"(W) X 24.0"(H) inches)



MAX Louvre Panel
Model : **MLP4561**



MAX 40 on **MLPRS4561**
(with Rod Stand)

Model : **MLP 4591**

457(W) X 910(H)mm.
17.9"(W) X 35.8"(H) inch.



can accommodate
no. of MAX Crates
[MAX 20 : 18 nos.]
[MAX 30 : 12 nos.]
[MAX 40 : 12 nos.]

Model : **MLP 45183**

457(W) X 1830 (H)mm.
17.9"(W) X 72"(H) inches



can accommodate
the following
no. of MAX Crates
[MAX 20 : 36 nos.]
[MAX 30 : 24 nos.]
[MAX 40 : 24 nos.]

MLP4591L2DS2

Two legs with 2 MLP4591
(Double sided)

Model : **MLP45183**

(MAX Louvre Panel with MAX
crate30 and MAX crate40)

MOUNTING OF FPO CRATES ALSO ON LOUVRE PANEL

* → No. Of Rows

→ No. Of Columns

Model No. : MLP4545 (457 X 457 MM)

FPO 5	FPO 15	FPO 25	FPO 35	FPO 45
3*X4#=12	3*X4#=12	3*X3#=9	2*X3#=6	2*X2#=4

Model No. : MLP4561 (457 X 610 MM)

FPO 5	FPO 15	FPO 25	FPO 35	FPO 45
3*X5#=15	3*X5#=15	3*X4#=12	2*X4#=8	2*X3#=6

Model No. : MLP4591 (457 X 915 MM)

FPO 5	FPO 15	FPO 25	FPO 35	FPO 45
3*X8#=24	3*X8#=24	3*X6#=18	2*X5#=10	2*X4#=8

Model No. : MLP45183 (457 X 1830 MM)

FPO 5	FPO 15	FPO 25	FPO 35	FPO 45
3*X16#=48	3*X16#=48	3*X12#=36	2*X9#=18	2*X8#=16

PHARMA CRATES



Model : PHCC3719095

O.D. : 370 (L) X 195 (B) X 95 (H) mm.
 14.5" (L) X 7.6" (B) X 3.7"(H) inch.
 I . D. : 350 (L) X 160 (B) X 90 (H) mm.
 13.7" (L) X 6.2" (B) X 3.5"(H) inch.
 (Available with autoclave & non autoclave material)



Model : PHJBC3719095

O.D. : 370 (L) X 195 (B) X 95 (H) mm.
 14.5" (L) X 7.6" (B) X 3.7"(H) inch.
 I . D. : 350 (L) X 160 (B) X 90 (H) mm.
 13.7" (L) X 6.2" (B) X 3.5"(H) inch.
 (Available with autoclave & non autoclave material)



Model : PHJR4436080

O.D. : 440 (L) X 360 (B) X 80 (H) mm.
 17.3" (L) X 14.1" (B) X 3.1"(H) inch.
 I . D. : 418 (L) X 317 (B) X 74 (H) mm.
 16.4" (L) X 12.4" (B) X 2.9"(H) inch.
 (Available with autoclave & non autoclave material)



Model : PHF3719095

O.D. : 184 (L) X 86 (H) mm.
 7.2"(L) X 3.3"(H) inches

Two sizes available in CC/JBC/JR versions :

PH3719095

PH4436080



Model : PHF4436080

O.D. : 330 (L) X 72 (H) mm.
 12.9"(L) X 2.8"(H) inches



Model : CC33350



Model : CC33350LHS
 (with Lable Holder Slot)



Model : LID33350



Model : LH33350

IC 50 LTR.DRUMS



PLASTIC LID
 (with metal locking clip)

Model : IC-50 Ltr. DRUM

Top Dia. :	Bottom Dia. :
O.D. : 457 mm. / 17.9" approx.	370 mm. / 14.5" approx.
I . D. : 400 mm. / 15.7" approx.	
Height: 485 mm. / 19.0" approx.	360 mm. / 14.1" approx.



PLASTIC LID
 (without metal locking clip)

TOOL KIT CRATES



TOOL KIT CRATE - Small

O.D. : 479 (L) X 232 (B) X 222 (H) mm.
 18.8" (L) X 9.1" (B) X 8.7"(H) inch.
 I. D. : 434 (L) X 206 (B) X 158 (H) mm.
 17.0" (L) X 8.1" (B) X 6.2"(H) inch.
 Capacity : 15 kgs. approx.



SMALL TRAY

O.D. : 426 (L) X 199 (B) X 62 (H) mm.
 16.7" (L) X 7.8" (B) X 2.4"(H) inch.
 I. D. : 408 (L) X 181 (B) X 60 (H) mm.
 16.0" (L) X 7.1" (B) X 2.3"(H) inch.
 (Medium Tray also available)



TOOL KIT CRATE - Medium

O.D. : 555 (L) X 248 (B) X 222 (H) mm.
 21.8" (L) X 9.7" (B) X 8.7"(H) inch.
 I. D. : 512 (L) X 225 (B) X 198 (H) mm.
 20.1" (L) X 8.8" (B) X 7.7"(H) inch.
 Capacity : 18 kgs. approx.



TOOL KIT CRATE - Big

O.D. : 680 (L) X 298 (B) X 301 (H) mm.
 26.7" (L) X 11.7" (B) X 11.8"(H) inch.
 I. D. : 434 (L) X 206 (B) X 158 (H) mm.
 24.8" (L) X 10.3" (B) X 8.9"(H) inch.
 Capacity : 22 kgs. approx.



BIG TRAY

O.D. : 626 (L) X 259 (B) X 64 (H) mm. approx.
 24.6" (L) X 10.1" (B) X 2.5"(H) inch.
 I. D. : 607 (L) X 242 (B) X 60 (H) mm. approx.
 23.8" (L) X 9.5" (B) X 2.3"(H) inch.

SERICULTURE CRATES



Model No. : CC 96080 Crate

O.D. : 915 (L) X 600 (B) X 80 (H) mm.
 36.0" (L) X 23.6" (B) X 3.1"(H) inch.
 I. D. : 890 (L) X 570 (B) X 72 (H) mm.
 35.0" (L) X 22.4" (B) X 2.8"(H) inch.
 (Available in JBC, JSC & JR versions too)



Model No. : CC 96110 Crate

O.D. : 915 (L) X 600 (B) X 110 (H) mm.
 36.0" (L) X 23.6" (B) X 4.3"(H) in ch.
 I. D. : 890 (L) X 570 (B) X 98 (H) mm.
 35.0" (L) X 22.4" (B) X 3.8"(H) in ch.
 (Available in JBC, JSC & JR versions too)



Model No. : JSC 98070

O.D. : 967 (L) X 812 (B) X 70 (H) mm.
 38.0" (L) X 31.9" (B) X 2.7"(H) inch.
 I. D. : 935 (L) X 777 (B) X 60 (H) mm.
 36.8" (L) X 30.5" (B) X 2.3"(H) inch.

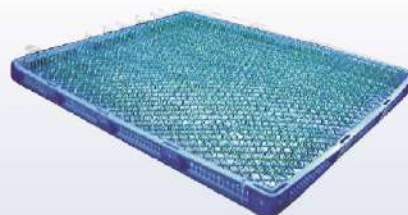

JR 98070 with Moutage

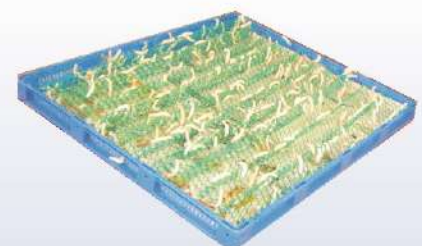

JR 98070 with cocoon producing silkworms

AUTOMOBILE CRATES



Injection Moulded Automobile Crates with special welded partitions

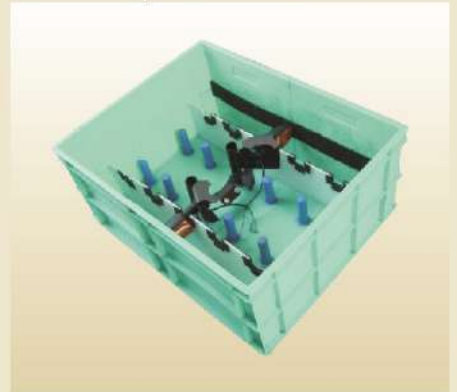

Injection moulded partitions made to carry rotor winding



PP Corrugated Automobile Crates with partitions

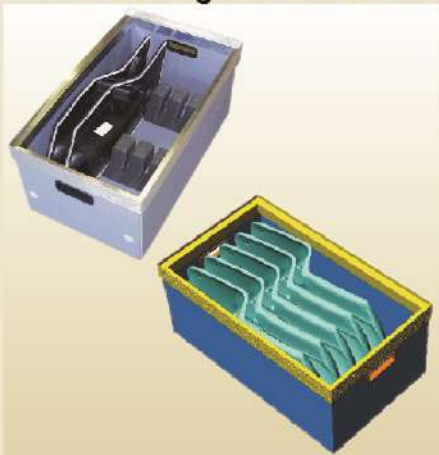

ACCESSORIES



All types of lable holders



Welded & Screwed Handles



'L' Type Pattis



Stems of different dia and height



Hard Foam



Soft Foam



Complete Closed Handle



Velcro



'U' type channel



Transparent Lable holders

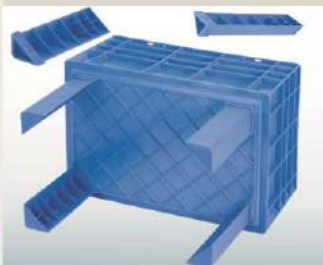

Legs provided available in different sizes

- a) Full Height : 300 mm. (11.8") approx. + height of crate
- b) Second Height : 265 mm. (10.4") approx. + height of crate
- c) Third Height : 230 mm. (9") approx. + height of crate
- d) Fourth Height : 125 mm. (4.9") approx. + height of crate
- e) Fifth Height : 75 mm. (2.9") approx. + height of crate



Transparent Flap for FPO53150 with locking pins



PVC Sheets



PVC Rod with Hinges



Plastic Pouch Lable Holders

ROTO MOULDED CRATES



Other available sizes :

RMC6666312	: O.D. : 665 (L) X 665 (B) X 312 (H) mm.	26.1" (L) X 26.1" (B) X 12.2"(H) inch.(Capacity : 125 ltrs. app.)
RMC6041585	: O.D. : 600 (L) X 410 (B) X 585 (H) mm.	23.6" (L) X 16.1" (B) X 23.0"(H) inch.(Capacity : 130 ltrs. app.)
RMC6041585	: O.D. : 600 (L) X 410 (B) X 585 (H) mm.	23.6" (L) X 16.1" (B) X 23.0"(H) inch.(Capacity : 130 ltrs. app.)
RMC6565370	: O.D. : 650 (L) X 650 (B) X 370 (H) mm.	25.5" (L) X 25.5" (B) X 14.5"(H) inch.(Capacity : 135 ltrs. app.)
RMC6666390	: O.D. : 665 (L) X 665 (B) X 390 (H) mm.	26.1" (L) X 26.1" (B) X 15.3"(H) inch.(Capacity : 150 ltrs. app.)
RMC13045315	: O.D. : 1300(L) X 450 (B) X 315(H) mm.	51.1" (L) X 17.7" (B) X 12.4"(H) inch.(Capacity : 155 ltrs. app.)
RMC84640	: O.D. : 815 (L) X 410 (B) X 635 (H) mm.	32.0" (L) X 16.1" (B) X 25.0"(H) inch.(Capacity : 190 ltrs. app.)
RMC8242640	: O.D. : 820 (L) X 420 (B) X 640 (H) mm.	32.2" (L) X 16.5" (B) X 25.1"(H) inch.(Capacity : 200 ltrs. app.)
RMC8254540	: O.D. : 820 (L) X 545 (B) X 540 (H) mm.	32.2" (L) X 21.4" (B) X 21.2"(H) inch.(Capacity : 220 ltrs. app.)
RMC8256600	: O.D. : 825 (L) X 565 (B) X 600 (H) mm.	32.4" (L) X 22.2" (B) X 23.6"(H) inch.(Capacity : 250 ltrs. app.)
RMC9462520	: O.D. : 948 (L) X 628 (B) X 520 (H) mm.	37.3" (L) X 24.7" (B) X 20.4"(H) inch.(Capacity : 300 ltrs. app.)
RMCT400	: O.D. : 1025(L) X 660 (B) X 645 (H)mm.	40.3" (L) X 25.9" (B) X 25.3"(H) inch.(Capacity : 400 ltrs. app.)
RMCT950	: O.D. : 1220(L) X 1070(B) X 830 (H)mm.	48.0" (L) X 42.1" (B) X 32.6"(H) inch.(Capacity : 950 ltrs. app.)



Model : RMCT1200(Roto Moulded Trolley Crate)

O.D. : 1530 (L) X 1070 (B) X 770 (H) mm.

60.2" (L) X 42.1" (B) X 30.3" (H) inches

Capacity : 1200 ltrs. approx.



Model : RMCT1450(Roto Moulded Trolley Crate)

O.D. : 1830 (L) X 1080 (B) X 780 (H) mm.

72" (L) X 42.5" (B) X 30.7" (H) inches

Capacity : 1450 ltrs. approx.

ROTO MOULDED CRATES



SALIENT FEATURES OF RMCT400, RMCT950, RMCT1200 & RMCT1450



Special Radius of
Corner Top Rim



Vertical Ribs &
Inside Bottom



Higher Thickness
of Corner Top Rim



Outside Bottom
Ribs

RMC : Roto Moulded Crate **RMCT** : Roto Moulded Crate with Trolley



RMC8254540 stacked



RMCT84640 used in Textile Industry



RMCT400 with Trolley



RMCT1200 with Trolley used in Textile Industry

ROTO MOULDED O.E.M. CRATES



Assembly Kit Roto Crate



Engine Cell Roto Crate



Crank Shaft Roto Crate



Partitioned Roto Crate



Nestable Roto Crate



**Precision Heavy
Components Roto Crate**



6 Gears Roto Crate

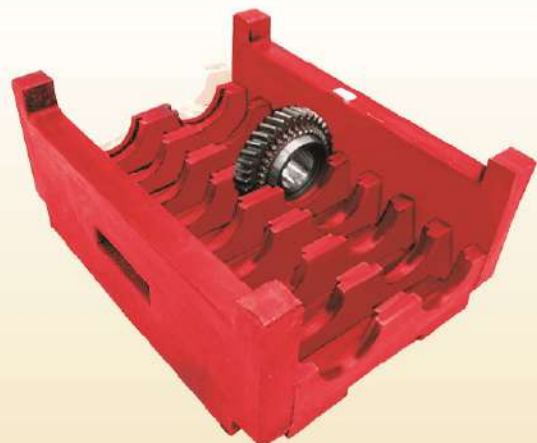

16 Gears Roto Crate

Stackable Nestable CRATES



Model CH5838210

O.D.: 580(L)X380(B)X210(H) mm.
 22.8" (L) X 14.9" (B) X 8.2"(H) inch.
 I.D.: 553(L)X353(B)X205(H) mm.
 21.7" (L) X 13.8" (B) X 8.0"(H) inch.
 Capacity : 40 ltrs. approx.



Model : JBC5838210

O.D.: 580(L)X380(B)X210(H) mm.
 22.8" (L) X 14.9" (B) X 8.2"(H) inch.
 I.D.: 553(L)X353(B)X205(H) mm.
 21.7" (L) X 13.8" (B) X 8.0"(H) inch.
 Capacity : 40 ltrs. approx.



Model : JBC6238300

O.D.: 626(L)X381(B)X300 (H) mm.
 24.6" (L) X 15" (B) X 11.8"(H) inch.
 I.D.: 590(L)X345(B)X293 (H) mm.
 23.2" (L) X 13.5" (B) X 11.5"(H) inch.
 Capacity : 48 ltrs. approx.



Model : JR 6238300

O.D.: 626(L)X381(B)X300 (H) mm.
 24.6" (L) X 15" (B) X 11.8"(H) inch.
 I.D.: 590(L)X345(B)X293 (H) mm.
 23.2" (L) X 13.5" (B) X 11.5"(H) inch.
 Capacity : 48 ltrs. approx.



Model :CH 63325 (SN Crate)

O.D. : 650 (L) X 370 (B) X 325 (H) mm
 24.6" (L) X 15" (B) X 11.8"(H) inch.
 I . D. : 485 (L) X 300 (B) X 295 (H) mm
 23.2" (L) X 13.5" (B) X 11.5"(H) inch.
 Capacity : 50 ltrs. approx.



Model :CH 63325 (When nested) Stacked Height 100 mm.



Model :CH 63325 (When stacked) Stacked Height 300 mm.

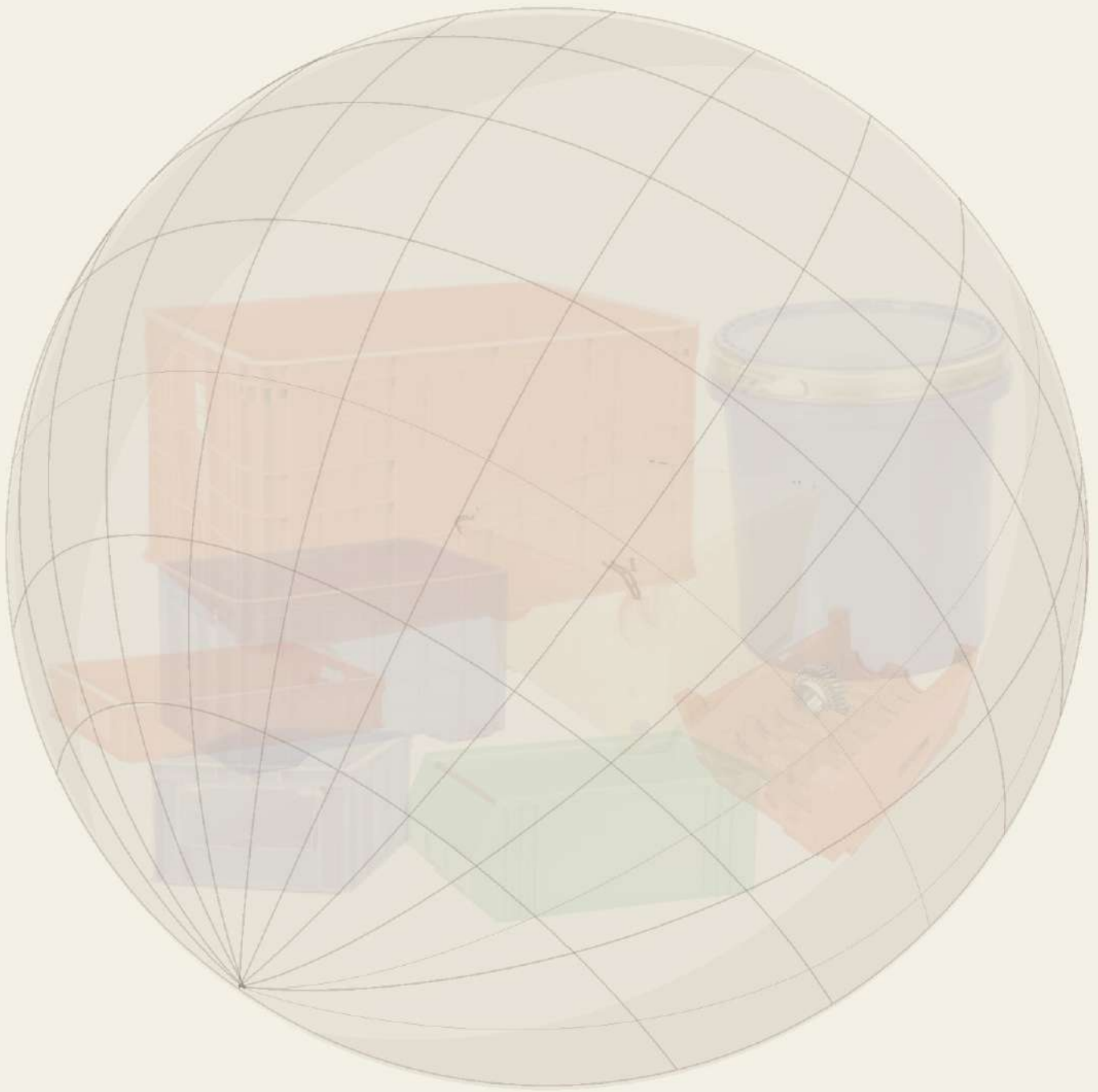

LAHDAN GROUP OF COMPANIES MAIN OFFICE: DUBAI - UNITED ARAB EMIRATES

P.O BOX 31908 DUBAI

TEL: +971 4 267 9130 / 267 6110

FAX: +971 4 267 9140

MOBILE: +971 50 6540 875 / 55 2118 884 EMAILS: Lahdanac@gmail.com / Lret@eim.ae

WEBSITE: www.lahdanuae.com

This catalogue is issued to provide outline information only & is not deemed to form part of an offer or contract. Our policy is of continuous improvement & we reserve the right to change details without prior notice.